

AVUE, AVUX, AVUM, MK 5



FEATURES

- Models available to fit VEU, MEU, FEU, VZX and MZX valves
- Accurate positioning
- Simple installation and commissioning (self referencing/auto stroking)
- Direct coupling to valves without the need for linkage kits or mounting brackets
- Actuator fits to the valve without the use of tools
- Built-in Manual Override supplied as standard (screwdriver operated for security)
- Neat compact design eases fitting in terminal units
- Fly lead simplifies wiring to the controller
- Approved to European EMC and safety standards
- Manual Override Reset facility (AVUE)
- Short stroke (9.5mm) and long stroke (12.7mm) AVUE models available, both direct and reverse acting
- 0-10Vdc control signal input (AVUE); 3-point modulating signal (AVUX & AVUM)
- Connect up to 10 AVUE actuators in parallel from one IAC, KMC, MMC, MN, BAS or Satchwell (Sigma) controller output

The AVUEs are modulating actuators having a linear output drive; they can be used in conjunction with any controllers providing a 0-10Vdc output signal to operate Satchwell VEU, MEU, FEU, VZX and MZX valves. The short stroke (9.5mm) versions (both direct and reverse acting) are compatible with VEU (Mk 4) 2-port, MEU (Mk 4) 3-port and FEU (Mk 5/6) 4-port control valves. The long stroke (12.7 mm) versions (both direct and reverse acting) are compatible with VZX 2-port and MZX 3-port valves. All these control valves are applied, typically, to regulate the flow of either hot or chilled water supplying heating or cooling coils in various types of terminal unit, for example fan coil units, reheat coils associated with variable air volume units, also small air handling plants and heat exchangers.

The AVUX is a 24Vac modulating linear actuator suitable for modulating compatible Satchwell valves from any 24Vac, 3-point controller or device. The AVUM is a mains voltage (230Vac) modulating linear actuator which can be controlled from any controller or device having a 3-point mains switched output. Both the AVUX and the AVUM valve actuators are suitable for use with VEU (Mk 4) 2-port, MEU (Mk 4) 3-port and FEU (Mk 5/6) 4-port valves, also the VZX 2-port valve and the MZX 3-port valve.



SPECIFICATIONS

Order Type:	AVUE5305	AVUE5355	AVUE5304	AVUE5354	AVUX5202	AVUM5601
Input Control Signal:	0-10Vdc				24Vac	230Vac
Control Action:	Direct Acting (DA)	Reverse Acting (RA)	Direct Acting (DA)	Reverse Acting (RA)	Floating	
Stroke (mm):	9.5	9.5	12.7	12.7	9.5 or 12.7 depending on valve fitted	
Stroke Time (s):	85	85	110	110	85 or 110s depending on valve stroke length	
Thrust (N) (Minimum):	220					
Power Supply:	AVUE/AVUX: 24Vac ± 10%, 50Hz, AVUM: 230Vac (±10%), 50Hz					
Power Consumption (VA) (Maximum):	3.1	3.1	3.1	3.1	2.3	3.6
Protection Class:	IP 40					
EMC:	En61326 1997 & FCC					
Safety:	EN60730-1					
Ambient Temperatures:	Operating: 0 to 50°C Storage/Transit -40 to 70°C					
Ambient Humidity:	Operation & Storage: 0% to 95% rh non-condensing					
Case:	Moulded plastic housing (fire resistance to UL94V-0)					
Drive:	Operates on a screw jack principle, driven by a reversible synchronous motor via a gear train and magnetic clutch.					
Motor:	Split phase, capacitor reversing type, continuously rated.					
Spindle Coupling:	Claw coupling.					
Manual Override:	Adjusted by means of a screwdriver slot in the top of the cover. AVUE has a reset button on underside for use when manual override is operated when unit is powered up.					
Mounting Attitude:	See Installation on Page 4 for details.					
Wiring:	Colour coded fly lead, 1.5m long, 3 core.					
Associated Controllers (AVUE):	CZT	-DS 2.105				
	DRTE	-DS 1.101				
	IAC	-DS 2.951, 2.801				
	KMC	-DS 2.120				
	MMC	-DS 2.701				
	MN	-DS 10.101,2,3,4				
	BAS	-DS 13.351, DS 13.310, DS 13.320, DS 13.321				
	Sigma	-DS 13.353, DS 13.311, DS 13.322, DS 13.323				
Associated Controllers (AVUX, AVUM):	AVUX: CSC	-DS 2.021				
	MMC	-DS 2.701				
	CXT	-DS 2.101				
	CXR	-DS 2.110				
	IAC	-DS 2.801, 2.951				
	URC	-DS 13.301				
	AVUM: CSC	-DS 2.021				

AVUE ACTUATORS GUIDE TO SELECTION

The 'AVUE' unit valve actuators are factory set with respect to Direct Acting (DA)/Reverse Acting (RA) control action to minimise site installation and commissioning time. To ensure correct selection of actuator specification to suit the particular application, controller and type of control valve, please refer to the tables and diagrams below.

CONVENTION OF OPERATION OF DIRECT AND REVERSE-ACTING ACTUATORS

Action	Signal	Spindle Position			Position of ports 1-2 VZX, VEU (Mk 4), MZX, MEU (Mk 4), FEU (Mk 5/6)
		Retracted		Extended	
Direct Acting (DA)	0V	Retracted		0%	Closed
	10V	Extended		100%	Open
Reverse Acting (RA)	0V	Extended		100%	Open
	10V	Retracted		0%	Closed

AVUE ACTUATOR/VALVE COMPATIBILITY

ACTUATOR	Valve				
	VEU Mk4 (2 Port) (VEU 4 series)	MEU Mk4 (3 Port) (MEU 4 series)	FEU Mk5/6 (4 Port) (FEU 5/6 series)	VZX (2 Port) (VZX 4 series)	VZX (2 Port) (VZX 4 series)
AVUE5305 (Short stroke, DA)	Yes	Yes	Yes	No	No
AVUE5355 (Short stroke, RA)	Yes	Yes	Yes	No	No
AVUE5304 (Long stroke, DA)	No	No	No	Yes	Yes
AVUE5354 (Long stroke, RA)	No	No	No	Yes	Yes

AVUE APPLICATIONS

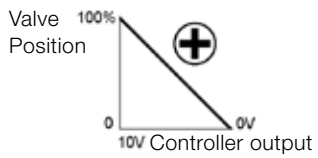
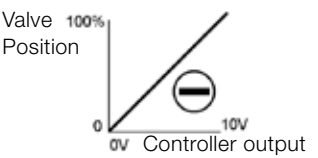
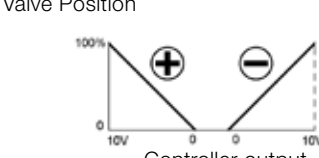
Single-stage Heating	Single-Stage Cooling	Two-Stage, Heating and Cooling (Two separate 0-10Vdc controller outputs)
Controller	Controller	Controller
DRTE, CZT, MN, MMC, BAS Sigma, IAC, KMC	DRTE, CZT, MN, MMC, BAS Sigma, IAC, KMC	CZT, MN, MMC, BAS Sigma, IAC, KMC
 <p>Valve Position</p> <p>100% 0V 10V Controller output</p> <p>Low ← Temperature → High</p>	 <p>Valve Position</p> <p>100% 0V 10V Controller output</p> <p>Low ← Temperature → High</p>	 <p>Valve Position</p> <p>100% 0V 10V Controller output</p> <p>Low ← Temperature → High</p>

AVUE ACTUATOR/VALVE COMBINATIONS

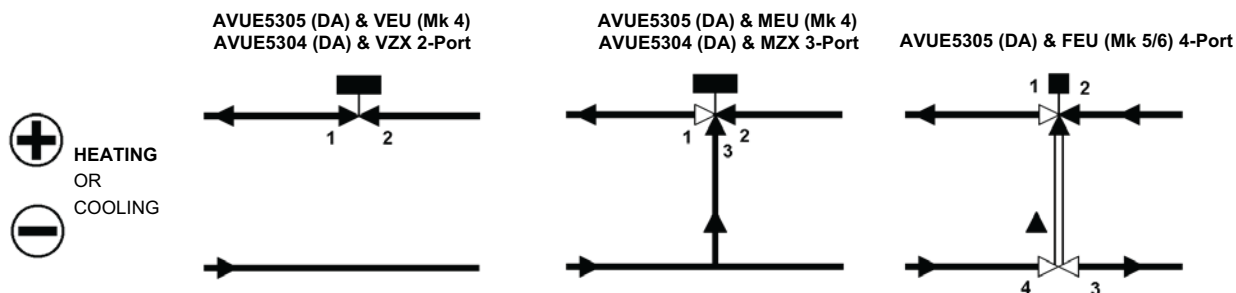

AVUX, AVUM, ACTUATORS

ACTUATOR	Valve				
	VEU Mk4 (2 Port) (VEU 4 series)	MEU Mk4 (3 Port) (MEU 4 series)	FEU Mk5/6 (4 Port) (FEU 5/6 series)	VZX (2 Port) (VZX 4 series)	MZX (3 Port) (MZX 4 series)
AVUX, AVUM	Yes	Yes	Yes	Yes	Yes

INSTALLATION

Location

Warnings - steam or hot water hazard. Before removing actuator from valve or opening valve, ensure that the valve control medium is isolated and relieve the pressure. Work should only be carried out by a competent engineer.

The AVUM is at mains potential. Local wiring precautions and usual safety precautions must be observed. Do not remove the cover as mains potential will be exposed.

Cautions

Ambient temperature must be within limits 0 to 50°C.

Never run the actuator without a valve attached to it.

Ensure that location is reasonably clean and dry with adequate access for fitting and wiring.

Do not install near large contactors, electrical machinery, or welding equipment.

Do not install with actuator below level of valve.

Do not apply any voltages until a qualified technician has checked the system and the commissioning procedures have been completed.

Applying power to the actuator before fitting to the valve will drive the actuator spindle away from its preset installation position and adjustment of the Manual Override will then be required to enable fitting to the valve.

Note: There is no need to remove the actuator cover.

1. Check that actuator specification number is correct for the application (see Commissioning Note 1) and that it is the correct voltage for the controller or device being used.
2. Ensure that the two captive fixing screws (A) in the mounting frame are fully retracted. With the valve spindle (B) fully withdrawn, tilt the actuator and lower it over the valve so that the claw coupling (C) on actuator spindle engages with the grooved bush on top of the valve spindle.
3. Lower the actuator frame onto the valve until it is flush with the valve clamping face. Finger tighten the two captive screws. Tools are not required.

Note: The claw coupling should already be in the optimum position; if not, adjust the Manual Override on the top of the unit (a small, flat-blade screwdriver will be required; turning the screw clockwise will drive the claw coupling down).

4. Connect the colour-coded fly lead to the controller, as in the appropriate connection diagram (see Page 5), observing cable length and resistance limitations under 'Wiring Precautions'. Ensure the cable is routed clear of valve and pipework.

INSTALLATION

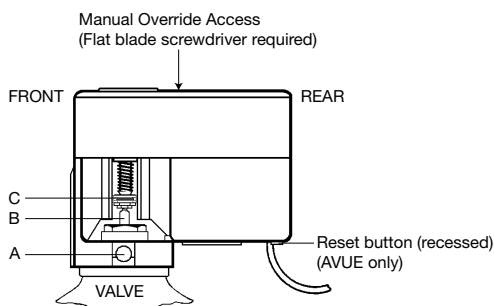

COMMISSIONING

1. Check that actuator specification number is correct for application by reference to identification label. See 'Guide to Selection' and that it is the correct voltage for the controller or device being used.
2. Check ambient temperature conditions.
3. Check that the actuator has been correctly assembled to the valve as directed in the installation instructions and that the fly lead is routed clear of the valve body and pipework.
4. Check that the control circuit wiring is correct and in accordance with the overall control system wiring diagram.
5. Switch on the ac supply and adjust the controller set value to check that the actuator operates through its full stroke and in the correct direction with respect to high or low set value settings. Check that the actuators and valves operate in the correct sequence with two-stage control systems. Refer to the actuator selection guide.
6. Check for correct operation of the valve when power is applied from the controller or device and that the actuator operates in both directions.
7. Wait approximately 85 seconds (short stroke models) or 110 seconds (long stroke models) for the valve to self reference.

WIRING PRECAUTIONS

Wiring from actuator to controller ^a	Max. length 1.5mm ² cable unscreened	Max. resistance per conductor
AVUE 24Vac supply	100m	3Ω
AVUE 0-10Vdc signal	100m	50Ω
AVUE 24Vac	100m	5Ω
AVUM - 230Vac	100m	10Ω

^a When wiring to BAS or Sigma controllers refer to the appropriate controller Data Sheet for the wiring precautions.

MANUAL OVERRIDE RESET FACILITY (AVUE only)

The purpose of the Reset button (on the underside of the AVUE actuator) is to cause the actuator to drive to a point of self reference. A Reset is required only in the following circumstances:

1. If the Manual Override has been operated when the actuator is powered up
2. If it is necessary to re-align the actuator to a point of self reference during maintenance. The AVUE will automatically reset on restoration of power, following a power failure.

For longer lengths, increase cable size and observe maximum resistance shown in the table. Screen the wiring using either screened cable or MICC and earth the screen at the controller only.

For longer lengths of AVUE 24Vac supply wiring, increase cable size and observe maximum resistance, also run separate return from 0V connection (Black). See connections diagram.

Note: Up to 10 AVUEs may be connected in parallel to a single IAC, KMC, MMC, MN, BAS or Sigma controller output.

CONNECTIONS

Basic Diagram

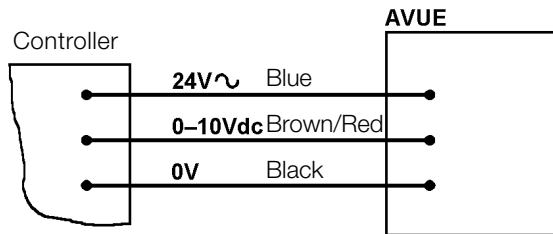

Up to 10 AVUE actuators can be connected in parallel. Ensure that the 24Vac supply is rated to operate the number of AVUEs connected to it.

Separate 24 Volt Power Supply

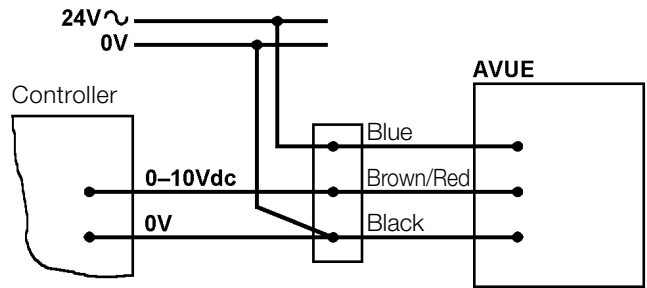

Up to 10 AVUE actuators can be connected in parallel. Ensure that the 24Vac supply is rated to operate the number of AVUEs connected to it.

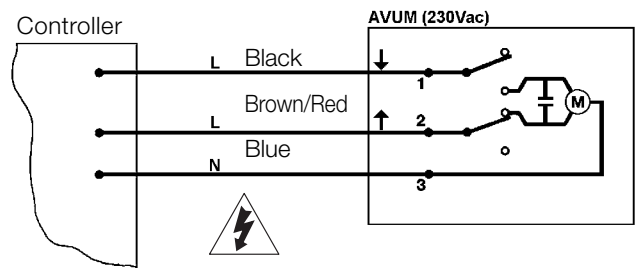
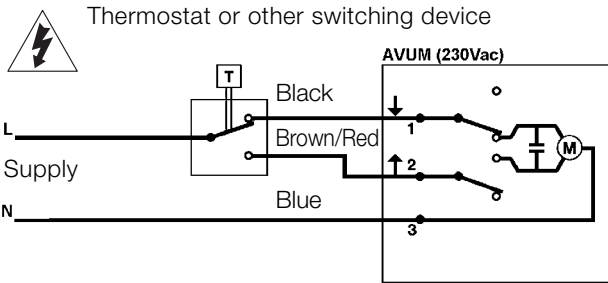

Thermostat or other switching device

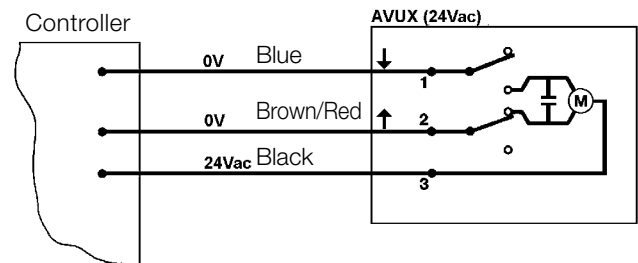
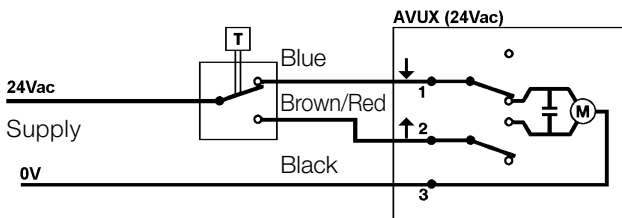

DIMENSIONS mm (in)

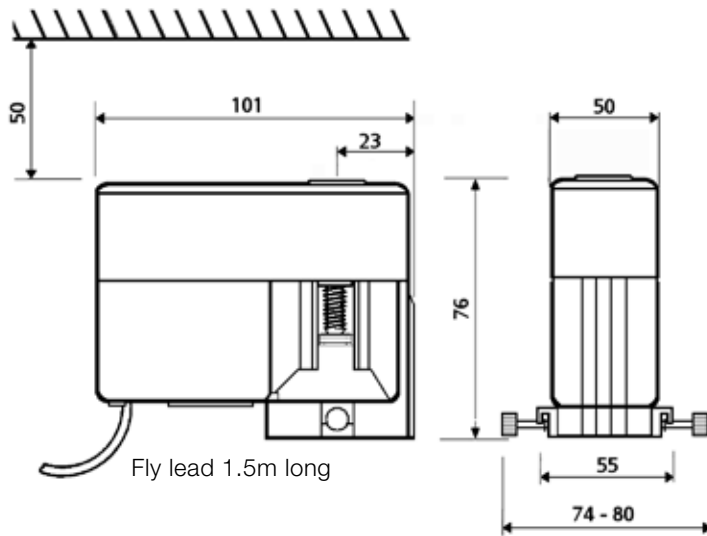

Weight: AVUE 333g
 AVUX 320g
 AVUM 400g

Warnings - Warning - Steam or hot water hazard. Before removing actuator from valve or opening valve ensure that the valve control medium is isolated and relieve the pressure. Work should only be carried out by a competent engineer.

The AVUM is at Mains potential. Local wiring precautions and usual safety precautions must be observed. Do not remove the cover as mains potential will be exposed.

Cautions

- The AVUE is a low voltage (24Vac) device and should only be used with the appropriate TAC Satchwell controllers. Local wiring precautions and usual safety precautions must be observed.
- Observe wiring precautions on Page 6.
- Observe installation instructions on Page 4.
- Do not apply any voltages until a qualified technician has checked the system and the commissioning procedures have been completed.
- Applying power to the actuator before installing on the valve will drive the actuator spindle away from its preset installation position and adjustment of the Manual Override will then be required to enable fitting to the valve.
- If any equipment covers have to be removed during the installation of this equipment, ensure that they are refitted after installation to comply with UL and CE safety requirements.
- Do not install near large contactors, electrical machinery, or welding equipment.
- Observe maximum and minimum ambient temperatures.
- Check maximum differential pressure of valve to be driven. Do not exceed maximum differential pressure.
- Interference with parts under sealed covers invalidates the guarantee.
- Design and performance of TAC Satchwell equipment is subject to improvement and therefore liable to alteration without notice.
- Information is given for guidance only and TAC Satchwell does not accept responsibility for the selection and installation of its products unless information has been given by the Company in writing relating to a specific application.
- A periodic system and tuning check of the control system is recommended. Please contact your local sales office for details.