

DEPA[®]

brands you trust.



Technical Datasheet
DEPA DH[®] Next Generation
Air Operated Double Diaphragm Pumps

CRANE[®]

Crane ChemPharma & Energy

www.depapumps.com
www.cranecpe.com

Features and Benefits

DEPA DH® Next Generation Air Operated Double Diaphragm Pump Series DH15, DH25, DH40, DH50 and DH80 are made of cast aluminum developed for high efficiency operations within industrial applications.

Key Features

- ❶ Special Pump Design with Flexible Multiport-Connections* & Free Flow Path manifold
- ❷ Cast feet integrated in the center block housing enables maintenance in place
- ❸ Block mounted pump and air chambers provide a safe and well-defined diaphragm clamping mechanism

*also available with single port connections.



Sizes

DEPA DH® Next Generation Air Operated Double Diaphragm Pumps of aluminium series are available in the nominal sizes of ½" (DH15), 1" (DH25), 1 ½" (DH40), 2" (DH50), and 3" (DH80). Equipped with DEPA® AirSave System or internal air-valve.

Type	15 (½")	25 (1")	40 (1½")	50 (2")	80 (3")
DHxx-FA	●	●	●	●	●

	Size				
	15	25	40	50	80
Suction height (m), dry ¹⁾³⁾	2.5	6.0	6.0	6.0	6.0
Max. solid size (mm)	3.5	10.0	16.0	18,0	25.0
Weight (kg)	2.0	8.2	12.0	35.4	55.0
Min. start-up pressure (bar)	0.5 ²⁾	0.5 ²⁾	0.5 ²⁾	1.5	1.5

1) At 2 bar air pressure (DH15/25), 7 bar (DH40/50/80)

2) AirSave System (M-valve)

3) For valve seat/valve ball combination of PTFE or stainless steel the suction height will be reduced

Applications

The aluminum housing material with universally selectable interior allows versatile application options.

- Painting industries & coating industries
- Printing machines & gluing machines
- Mechanical engineering and construction
- Automotive

Features and Benefits

Temperature

Operating temperature of aluminum -10°C to +130°C. Further limitations are as-per the table with product wetted interior parts.

Product wetted interior	Max. Temperature (°C)
NBR	-15 to +90
EPDM	-25 to +90
NRS	-15 to +70
FKM	-5 to +120
DEPA nopped S4®	-20 to +110
PTFE	-20 to +100
DEPA nopped E4®	-10 to +130

Applied Guidelines

- Machinery Directive 2006/42/EC
- ATEX compliant in accordance with directive 2014/34 EC equipment group II, category 2GD, Explosion group IIB Tx (II 2 GD IIB Tx)

Device Group	Device Category		Explosive Atmosphere		Explosion Group*		
			G	D	IIA	IIB	IIC
I	M1	-	not applicable				
	M2	●	not applicable				
II	1	-	-	-	-	-	-
	2	●	●	●	●	●	-

* Only in combination with ATEX certified pump. The fluid temperature prescribes the temperature class (Tx).

Marking and Identification

The pumps are provided with a nameplate including pump code, serial number, date of manufacturing, max. allowed temperature and pressure.

The DEPA® pump coding gives all information about size, material and equipment which allow accurate linkage for linkage to spare parts.



ATEX-compliant II 2GD IIB Tx



Materials & Characteristics

DH	
Housing Material	Aluminium
Design	Bolted
Surface	Painted
Center Block	Aluminium
Air chamber	Integrated in center block

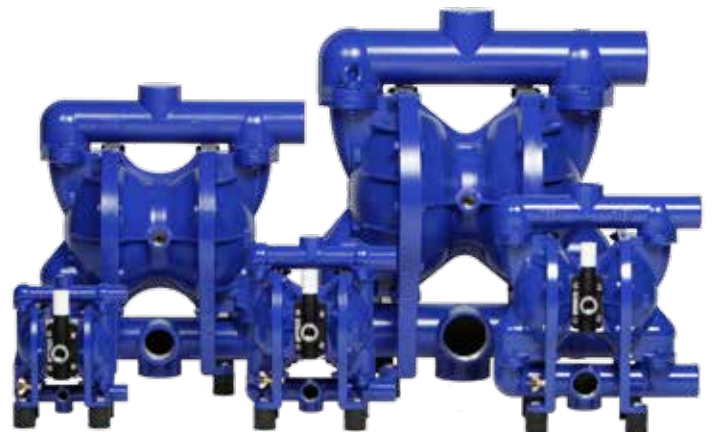

Pump Sizes and Equipment

DH 25 - FA - S E T

Connecting Dimension DH (mm) / inch	Housing Material
15 / ½"	Aluminium
25 / 1"	Aluminium
40 / 1 ½"	Aluminium
50 / 2"	Aluminium
80 / 3"	Aluminium

Material Options			
Material	Diaphragm	Valve Seat	Valve Ball
NBR	N	N	N ¹⁾
EPDM	E	E	E ¹⁾
NRS	B	B	B ¹⁾
FKM	F	F	-
DEPA nopped S ^{4*}	S	-	-
PTFE	T	T	T
DEPA nopped E ^{4*}	Z	-	-
Stainless Steel	-	R	R
NBR with core	-	-	Y ¹⁾
NRS with core	-	-	V ¹⁾

1) Not for size 15 (Further material options are available upon request)

Product Ports / Orientation of Multiport Manifolds						
		Discharge Port				
		D1	D2	D3	D4	D5
		(outlet to the top)	(outlet at opposite side of air inlet)	outlet right hand side / view to air inlet	(outlet at same side as air inlet)	(outlet left hand side / view to air inlet)
Suction Port	S1 (inlet from bottom)	A	B	C	O ¹⁾	P
	S2 (inlet aligned with air inlet)	D	-	E	Q ¹⁾	R
	S3 (inlet right hand side / view to air inlet)	F	G	H	T ¹⁾	U
	S4 (inlet at opposite side of air inlet)	I	J	K	W ¹⁾	X
	S5 (inlet left hand side / view to air inlet)	L	M	N	Y ¹⁾	Z

Product Ports / Orientation of Single Port Manifolds			
		Discharge Port	
		D2	D4
		(outlet at opposite side of air inlet)	(outlet at same side as air inlet)
Suction Port	S2 (inlet aligned with air inlet)	1	2
	S4 (inlet at opposite side of air inlet)	3	4

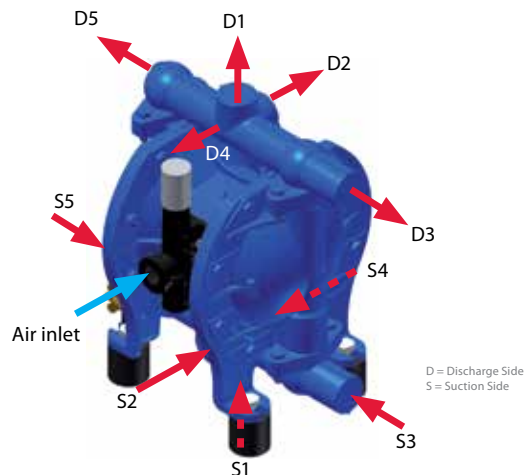

1) Not valid for DH15/DH25 with AirSave System

Dimensions Multiport

Dimensions (mm)	Size				
	15	25	40	50	80
A	136	165	182	243	296
B	207	272	370	502	568
C	180	241	307	414	522
D	266	340	437	572	717
E	52	61	80	88	105
F	34	38	50	70	90
G	99	116	116	120	120
H	116	154	206	275	340
I	89	122	155	296	367
K	174 (186) ¹⁾	234	266	351	434
L	18	23	30	18	15
M	105	134	165	226	280
Air inlet Internal Air Valve (inch)	G 3/8"			G 3/4"	
Air inlet AirSave Sytem (M-Valve) (inch)	G 1/2"			-	

1) External DEPA® AirSave System

Exploded view

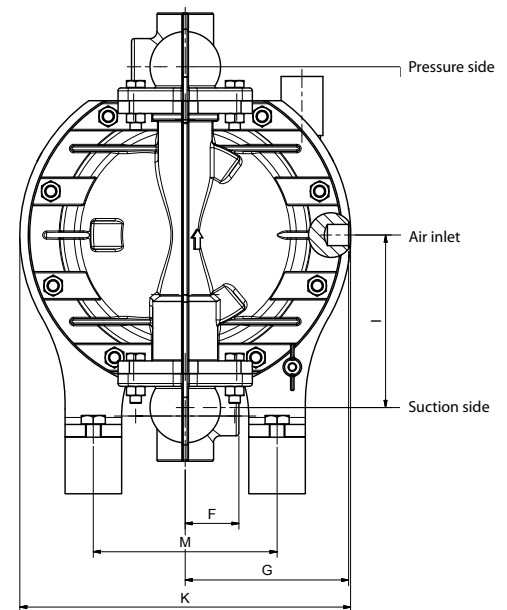
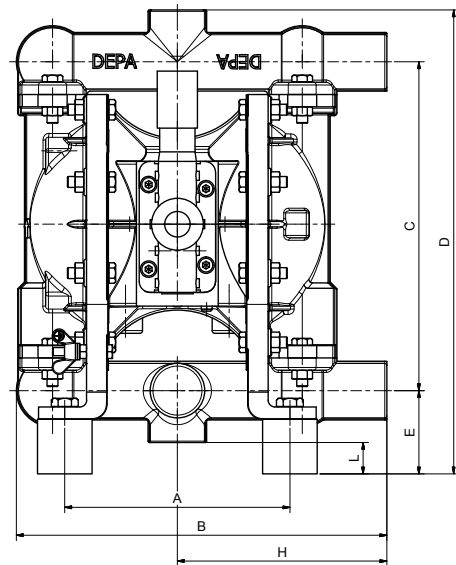
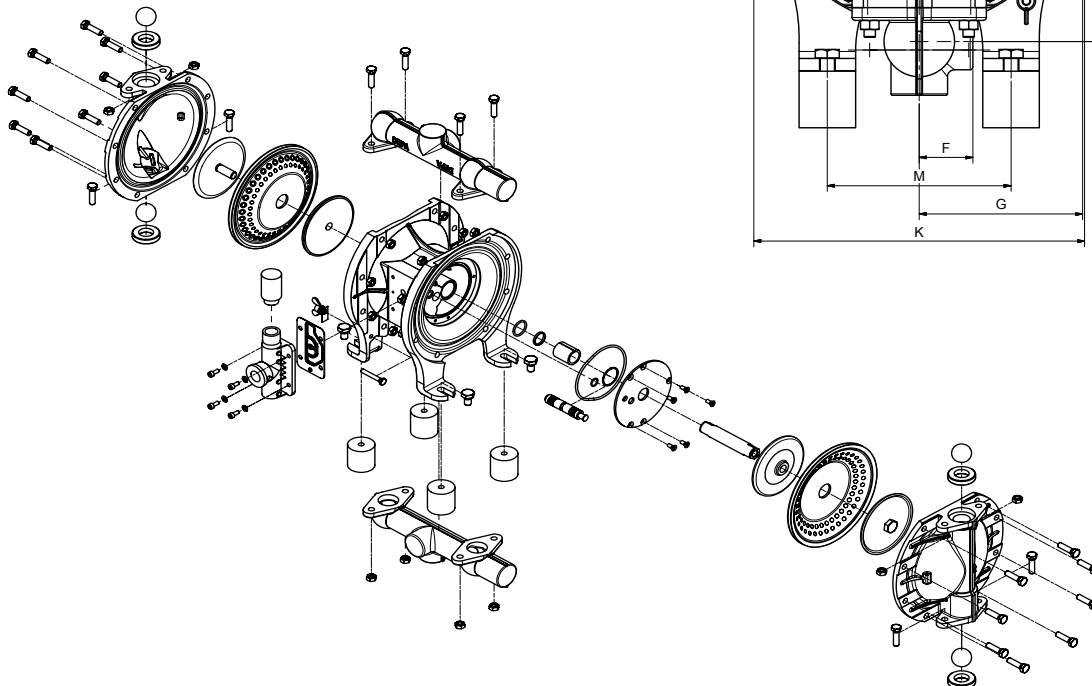

Dimensions Single Port

Dimensions (mm)	Size				
	15	25	40	50	80
A	136	165	182	243	296
B	181	236	328	455	562
C	180	241	307	414	522
D	252	329	418	543	682
E	52	61	80	88	105
F	34	38	50	70	90
G	99	116	116	120	120
H	116	154	206	275	340
I	89	122	155	296	367
K	174	234	266	351	434
M	105	134	165	226	280
Air inlet Internal Air Valve (inch)	G 3/8"			G 3/4"	
Air inlet AirSave Sytem (M-Valve) (inch)	G 1/2"			-	

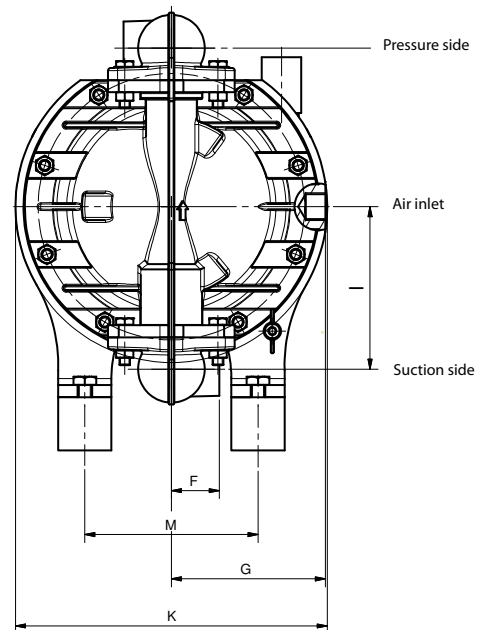
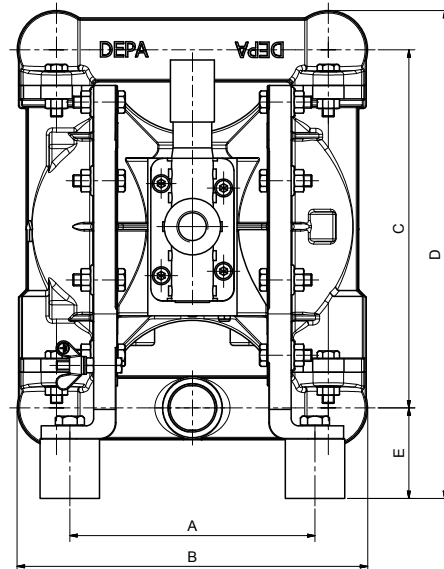

Exploded view

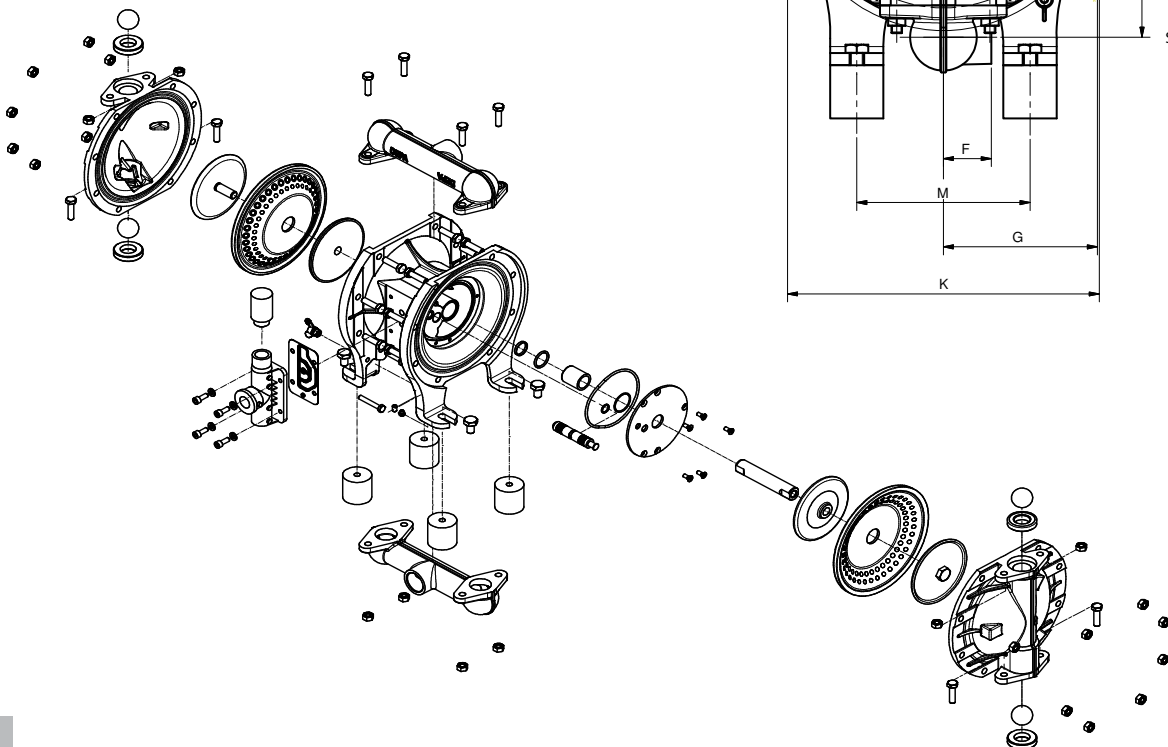

Performance Curves

Example for pump selection

Required is 2 m³/h as the flow rate at a discharge pressure of 4 bar. Recommend is the DH25 for this application. The needed air supply pressure is 4,3 bar. This equals an air consumption rate of 13 m³/h (between Ql = 10 m³/h and Ql = 20 m³/h).

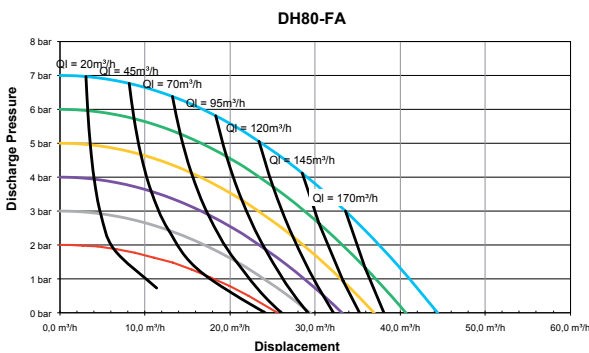
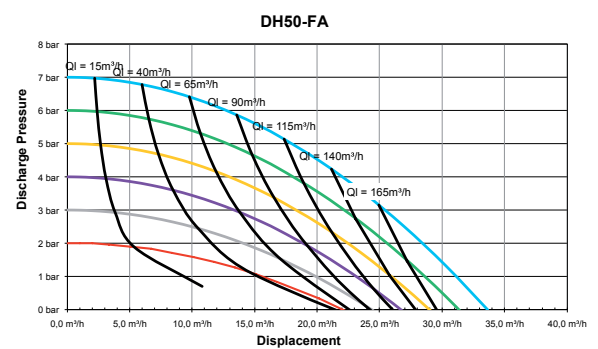
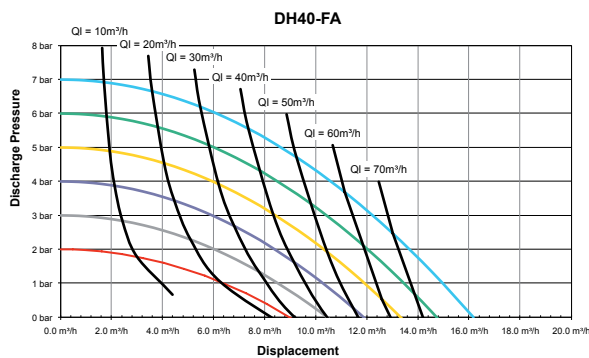
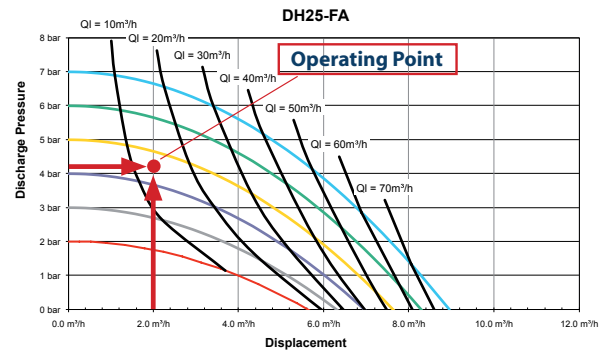
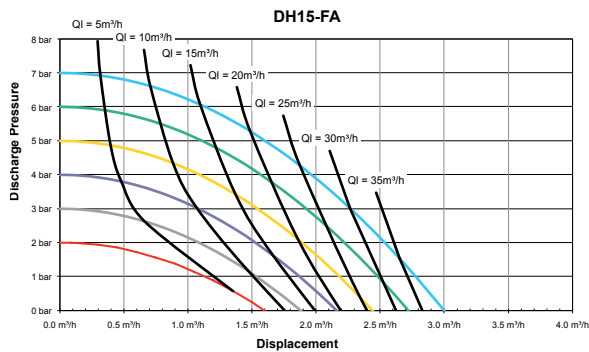

Curves are based on internal Air Valve only.

Please note that there is no impact on performance between single and multiport manifolds.

DEPA®

Crane ChemPharma & Energy

Crane Process Flow Technologies GmbH

Heerdter Lohweg 63-71

40549 Düsseldorf, Germany

Tel.: +49 211 5956-0

E-Mail: depa@cranecpe.com

www.cranecpe.com

www.depapumps.com

CRANE®

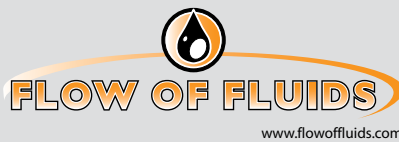

brands you trust.



CPE-DEPA-DH-TD-EN-A4-2016_12_31
Edition 12/2016

Crane Co., and its subsidiaries cannot accept responsibility for possible errors in catalogues, brochures, other printed materials, and website information. Crane Co. reserves the right to alter its products without notice, including products already on order provided that such alteration can be made without changes being necessary in specifications already agreed. All trademarks in this material are property of the Crane Co. or its subsidiaries. The Crane and Crane brands logotype, in alphabetical order, (ALOYCO®, CENTER LINE®, COMPAC-NOZ®, CRANE®, DEPA®, DUO-CHEK®, ELRO®, FLOWSEAL®, JENKINS®, KROMBACH®, NOZ-CHEK®, PACIFIC VALVES®, RESISTOFLEX®, REVO®, SAUNDERS®, STOCKHAM®, TRIANGLE®, UNI-CHEK®, WTA®, and XOMOX®) are registered trademarks of Crane Co. All rights reserved.