

PC400R-210-2UPN8X-H1141

Pressure Sensor – 2 PNP/NPN Transistor Switching Outputs

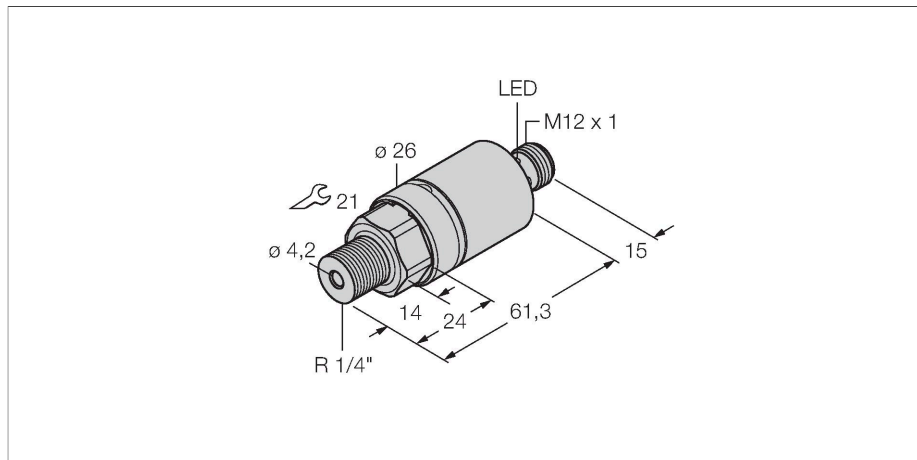

Features

- Cylindrical version without display
- 2 PNP/NPN switching outputs
- Communication via IO-Link
- Display of communication via LED at M12 connector
- Pressure range 0...400 bar rel.

Wiring diagram

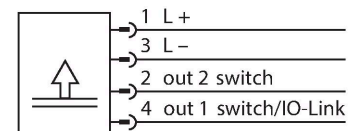

Technical data

Type	PC400R-210-2UPN8X-H1141
ID no.	6833801
Pressure range	
Pressure type	Relative pressure
Pressure range	0...400 bar
	0...5801.51 psi
	0...40 MPa
Admissible overpressure	≤ 700 bar
Burst pressure	≥ 700 bar
Response time	< 3 ms
Power supply	
Operating voltage	15...30 VDC
Current consumption	≤ 12 mA
Voltage drop at I _o	≤ 2 V
Protective measure	SELV; PELV according to EN 50178
Short-circuit/reverse polarity protection	yes / yes
Protection type and class	IP67 IP69K / III
Outputs	
Output 1	Switching output or IO-Link mode
Output 2	switching output
Switching output	
Communication protocol	IO-Link
Output function	NO/NC, PNP/NPN
Accuracy	± 0.5 % FS BSL
Rated operational current	0.15 A
Switching frequency	≤ 180 Hz

Functional principle

The IO-Link pressure transmitters of the PC 200 series operate with piezoresistive ceramic measuring cells. The ceramic diaphragm is unbalanced in proportion to the pressure applied. The digitally processed signal is made available via IO-Link or as switching output. Highest flexibility and 0.5 % f.s.accuracy guarantee secure connection to your processes.

Technical data

Switching point distance	≥ 0.5 %
Switch point:	(min + 0.005 x range) up to 100% f.s.
Release point(s)	min up to (SP - 0.005 x range)
Switching cycles	≥ 100 mil.
Switch point SP1	configurable
Release point rP1	customized
IO-Link	
IO-Link specification	V 1.0
Programming	FDT / DTM
Transmission physics	corresponds to 3-wire physics (PHY2)
Transmission rate	COM 2 / 38.4 kbps
Process data width	16 bit
Measured value information	14 bit
Switchpoint information	2 bit
Frame type	2.2
Accuracy	± 0.5 % FS BSL
Included in the SIDI GSDML	Yes
Temperature behaviour	
Medium temperature	-40...+85 °C
Temperature coefficient zero point Tk0	± 0.15 % of full scale/10 K
Temperature coefficient span T _{ks}	± 0.15 % of full scale/10 K
Ambient conditions	
Ambient temperature	-40...+80 °C
Storage temperature	-40...+80 °C
Vibration resistance	20 g (9...2000 Hz), according to IEC 68-2-6
Shock resistance	50 , acc. to IEC 68-2-27
Housing	
Housing material	Stainless steel, 1.4305 (AISI 303)/PBT-GF15
Pressure connection material	Stainless steel 1.4305 (AISI 303)
Pressure transducer material	Ceramics Al ₂ O ₃
Sealing material	FPM
Process connection	R 1/4" male thread DIN 2999
Wrench size pressure connection / coupling nut	21
Electrical connection	Connector, M12 × 1
Reference conditions acc. to IEC 61298-1	
Temperature	15...+25 °C
Atmospheric pressure	860...1060 hPa abs.
Humidity	45...75 % rel.

Technical data

Auxiliary power	24 VDC
Programming options	switch/release point, PNP/NPN, NO/NC, hysteresis/window mode, muting, pressure unit, peak pressure memory
MTTF	2079 years acc. to SN 29500 (Ed. 99) 40 °C

Accessories

Dimension drawing	Type	ID no.	
	WKC4.4T-2/TEL	6625025	Connection cable, female M12, angled, 4-pin, cable length: 2 m, sheath material: PVC, black; cULus approval; other cable lengths and qualities available, see www.turck.com
	RKC4.4T-2/TEL	6625013	Connection cable, female M12, straight, 4-pin, cable length: 2 m, sheath material: PVC, black; cULus approval; other cable lengths and qualities available, see www.turck.com
	RKC4.4T-2/TXL	6625503	Connection cable, female M12, straight, 4-pin, cable length: 2 m, sheath material: PUR, black; cULus approval; other cable lengths and qualities available, see www.turck.com
	WKC4.4T-2/TXL	6625515	Connection cable, female M12, angled, 4-pin, cable length: 2 m, sheath material: PUR, black; cULus approval; other cable lengths and qualities available, see www.turck.com
	RKC4.4T-P7X2-10/TXL	6626184	Connection cable, female M12, angled, 4-pin, cable length: 10m, sheath material: PUR, black; cULus approval; other cable lengths and qualities available, see www.turck.com

Accessories

Dimension drawing	Type	ID no.	
	USB-2-IOL-0002	6825482	IO-Link Master with integrated USB port

